

lanus

Luca Scacchetti
.88

lanus



INTRO

Designed for Tecno by Luca Scacchetti, lanus is a collection of managerial office furniture that includes desks, drawer units, tables and cabinets. The collection is rich in stylish details, boasts a striking classical design, and is made from hand crafted solid wood.

The various elements in the collection can be combined to create individual workstations with open or panel bases and various meeting configurations for small rooms and large, prestige environments too. All solutions feature a characteristic shaped edge in solid wood, but can be customised in size and finish to meet designer specifications.

The tables can assume various shapes and sizes, including elliptical meeting tables, square structures and bases with round tops and meeting tables with rectangular structures and tops.

The finishes are those that Tecno has applied to all its collections in order to facilitate the integration of different products in the same layout. For the tops, finishes include matt white and dark grey lacquer, and light, medium and dark oak, with grey and dark brown sides. Leather hand-rests can also be included. Table structures come in matt white and dark grey lacquer and dark oak, with dark brown sides.

The series is completed by various sizes of complementary side units and matching cabinets in the same finishes.

DESIGNER



Luca Scacchetti

Ianus

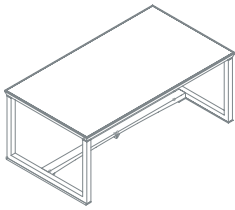

One base single top desk
1IA4811: L 180 D 100 H 72
1IA4812: L 210 D 100 H 72

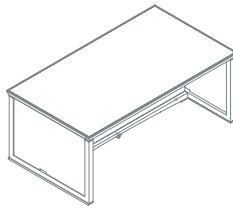

Panel base single top desk
1IA4821: L 180 D 100 H 72
1IA4822: L 210 D 100 H 72

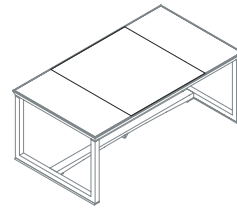

Open base desk arranged for leather insert
1IA4831: L 180 D 100 H 72
1IA4832: L 210 D 100 H 72

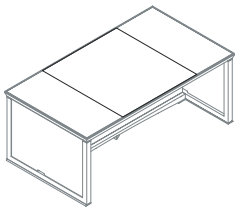

Desk panel base arranged for leather insert
1IA4841: L 180 D 100 H 72
1IA4842: L 210 D 100 H 72

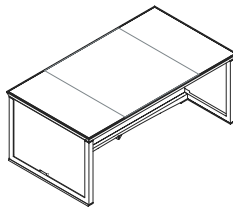

Leather insert
1IA3011

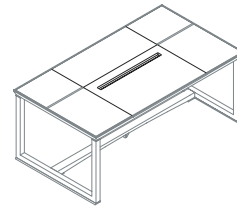

Open base desk with 6 elements top, liftable hand rest and object tray
1IA4851: L 180 D 100 H 72
1IA4852: L 210 D 100 H 72

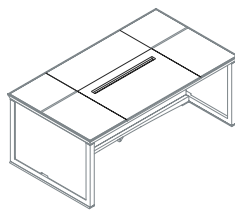

Panel base desk with 6 elements top, liftable hand rest and object tray
1IA4861: L 180 D 100 H 72
1IA4862: L 210 D 100 H 72

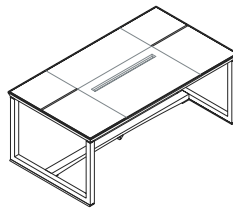

Hand rest with object tray
1IA3021

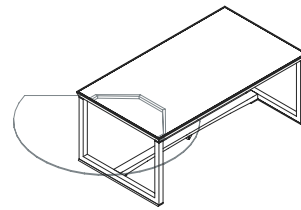

Circular side work top mounted on upright structure
1IA0311: L 137 D 157 (right)
1IA0312: L 137 D 157 (left)

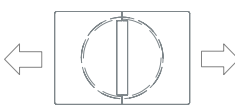

Chromed grommet
1IAMAG1500

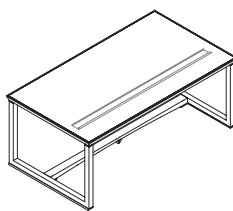

Horizontal cable tray
1IA1511: L 180
1IA1512: L 210

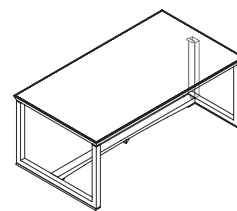

Vertical cable management
1IA1521

Ianus

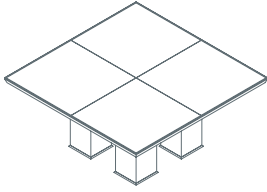

Meeting table, with square base and top
1IA4011: L 160 D 160 H 72

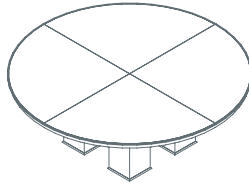
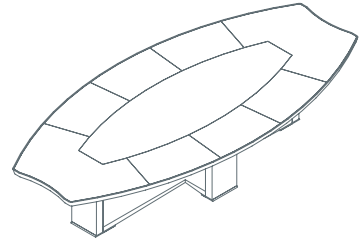
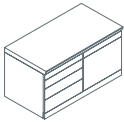

Table with square meeting base and round top
1IA4311: Ø 180 H 72



Meeting table, boat shaped top
1IA4611: L 280 D 145 H 72
1IA4612: L 350 D 165 H 72
1IA4613: L 420 D 180 H 72



Chest of drawers on castors with 5 drawers
 and 1 file drawer compartment
1IA5011: L 100 D 53,5 H 57

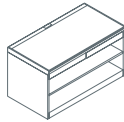

Open storage unit on castors
 with wooden pull-out shelf
1IA5021: L 100 D 53,5 H 57

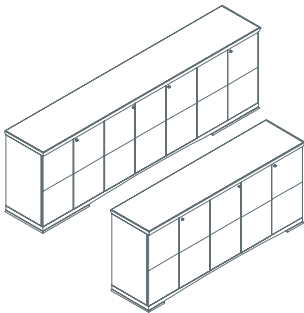

Cupboard
1IA5031: L 203 D 50 H 91 (5 doors)
1IA5041: L 283 D 50 H 91 (7 doors)

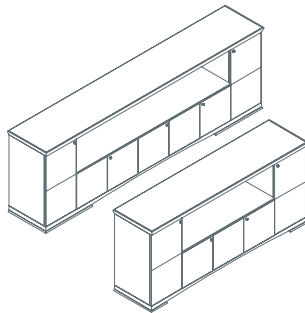

Cupboard with open compartment
1IA5051: L 203 D 50 H 91 (5 doors)
1IA5061: L 283 D 50 H 91 (7 doors)

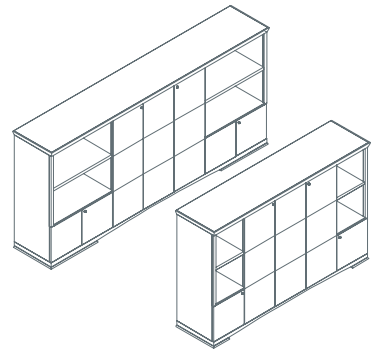

Cupboard with side compartments
1IA5071: L 203 D 50 H 131 (5 doors)
1IA5081: L 283 D 50 H 131 (7 doors)

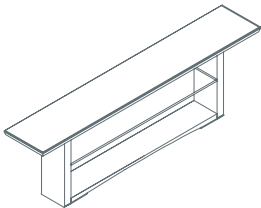

Side-board with glass shelf
1IA6510: L 240 D 50 H 85
1IA6520: L 280 D 50 H 85

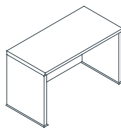

Typing element for desks
1IA0315: L 100 D 60 H 72
1IA0316: L 120 D 60 H 72